



A1WALLD1BRF/873 (FOTO)

Mobile refrigerato per l'esposizione del vino in bottiglia / Refrigerated Wine Cabinet

DESCRIZIONE/ DESCRIPTION

- Struttura con pannelli isolanti, laminato all'esterno / Structure with insulated laminated panels
- Porta con cornice in alluminio e vetrocamera / Aluminium profile door frame with glass bay
- Raffreddamento ventilato con controllo termostatico / Ventilated refrigeration digitally controlled
- Illuminazione a led e serratura alla porta / Door lock and internal led lighting
- Vaschetta con resistenza per lo smaltimento dell'acqua di condensa / Tank with resistor for disposal of condensed water
- Colori disponibili: grigio alluminio satinato (*873), nero semi-lucido(*421)./Available colours: Brushed Aluminium Gray (*873), semi-Glossy Black(*421)

CARATTERISTICHE TECNICHE / TECHNICAL DATA

T.A.:25°C - U.R. 60%	°C	BORDEAUX	H L P			H L P			Kg	Kg	Watt	[V/Ph/Hz]	HFC
CODICE/CODE	[°C]	up to	L	P	H	L	P	H	[Kg]	[Kg]	Watt	[V/Ph/Hz]	HFC
A1WALLD1BRF/*	+6°C÷+20°C	120	1200	650	1360	1300	760	1610	80	90	380	230/1/50	R404A
A1WALLD1SRF/*	+6°C÷+20°C	120	1200	650	1360	1300	760	1610	80	90	380	230/1/50	R404A



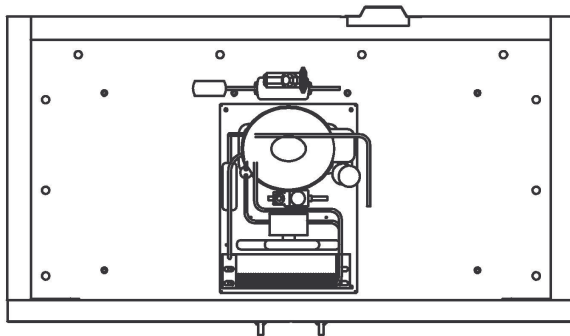
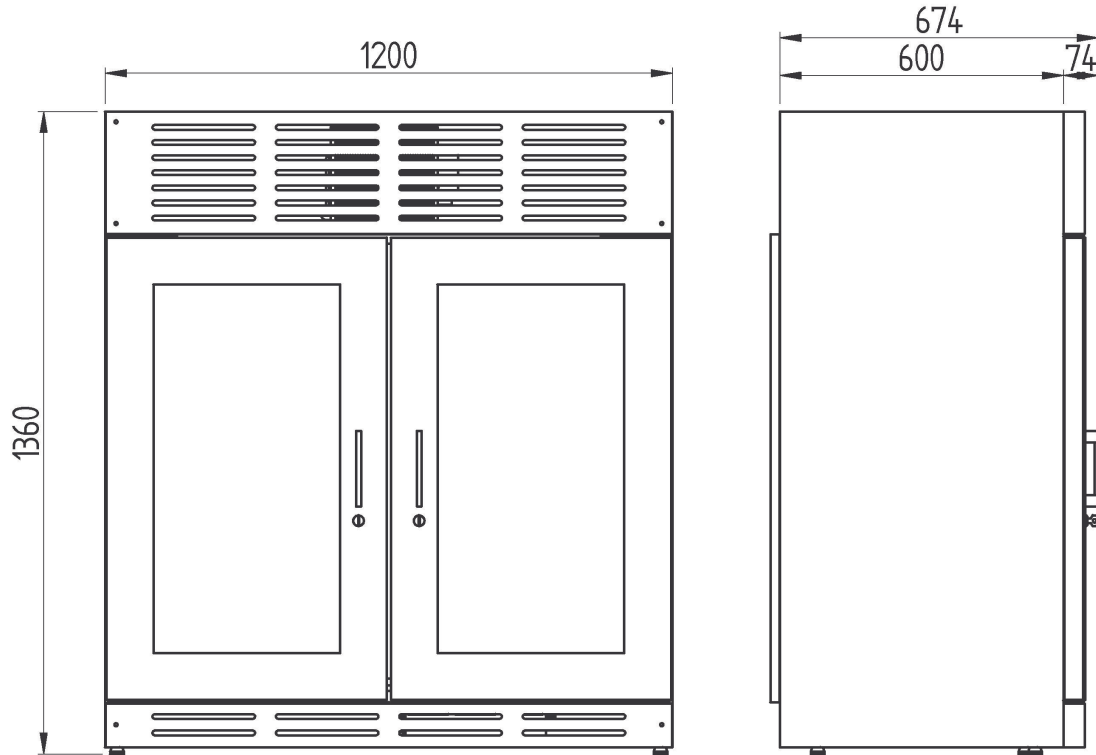











A1WALLD1BRM/873 (FOTO)

Mobile refrigerato per l'esposizione del vino in bottiglia / Refrigerated Wine Cabinet

DESCRIZIONE/ DESCRIPTION

- Struttura con pannelli isolanti, laminato all'esterno / Structure with insulated laminated panels
- Porta con cornice in alluminio e vetrocamera / Aluminium profile door frame with glass bay
- Raffreddamento ventilato con controllo termostatico UNITA' REMOTA / Ventilated refrigeration digitally controlled REMOTE UNIT
- Illuminazione a led e serratura alla porta / Door lock and internal led lighting
- Vaschetta con resistenza per lo smaltimento dell'acqua di condensa / Tank with resistor for disposal of condensed water
- Colori disponibili: grigio alluminio satinato (*873), nero semi-lucido(*421)./Available colours: Brushed Aluminium Gray (*873), semi-Glossy Black(*421)

CARATTERISTICHE TECNICHE / TECHNICAL DATA

T.A.:25°C - U.R. 60%													
CODICE/CODE	[°C]	up to	L	P	H	L	P	H	[Kg]	[Kg]	Watt	[V/Ph/Hz]	HFC
A1WALLD1BRM/*	+6°C÷+20°C	120	1200	650	1220	1300	760	1470	70	80	10	230/1/50	R404A
A1WALLD1SRM/*	+6°C÷+20°C	120	1200	650	1220	1300	760	1470	70	80	10	230/1/50	R404A



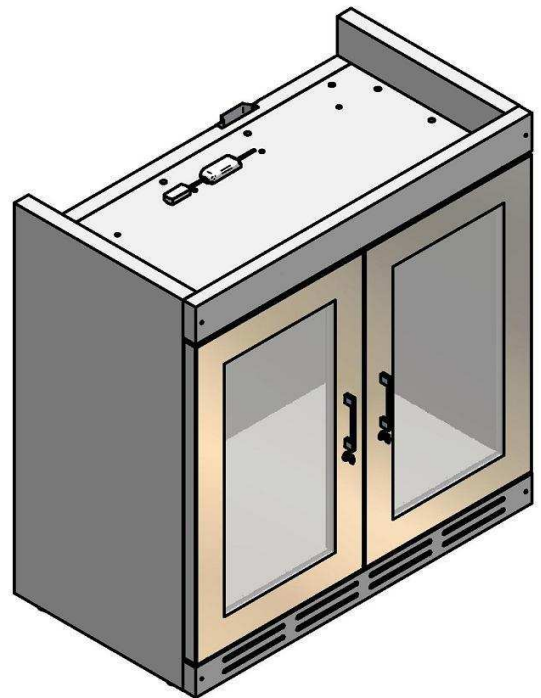
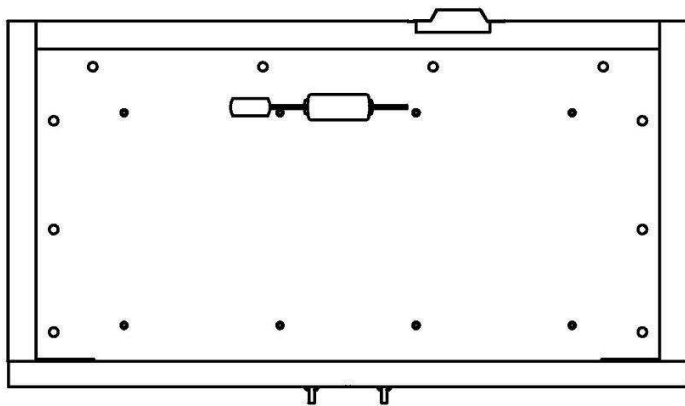
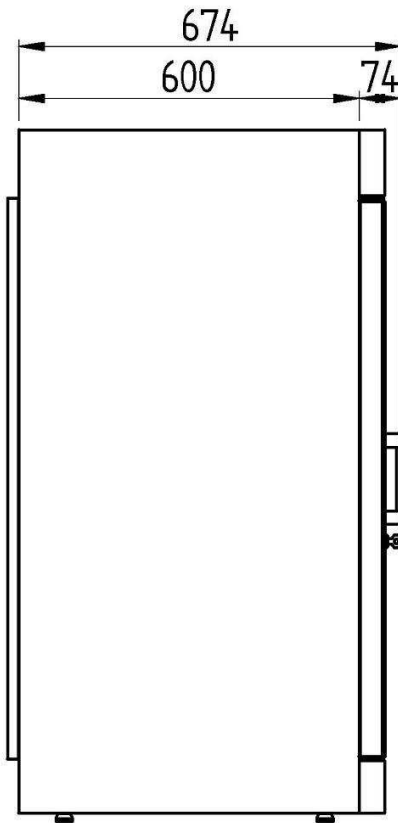
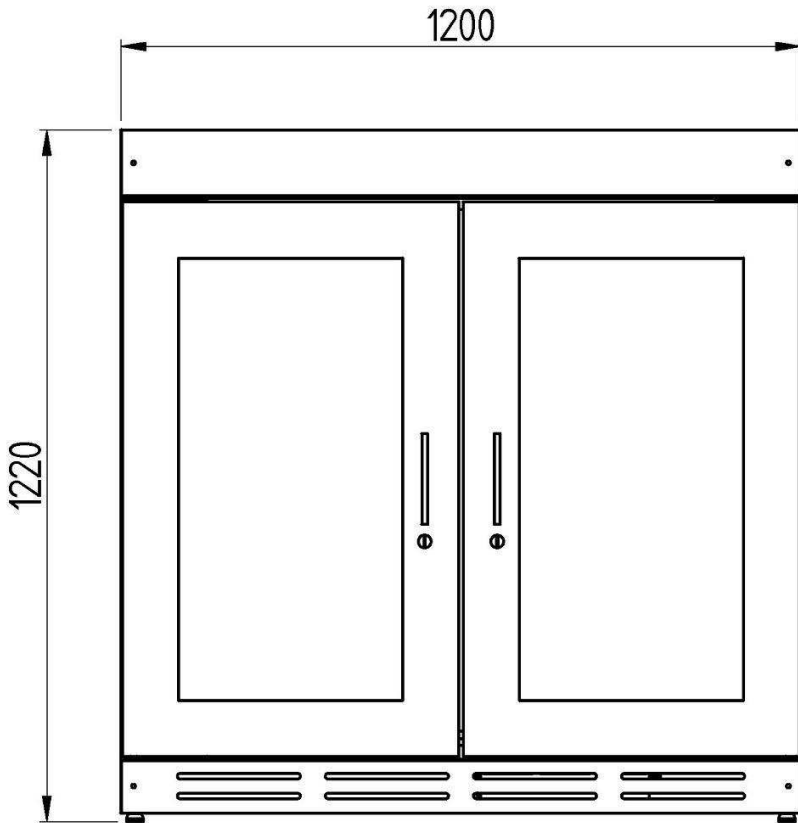











A1WALLD2BRFRF/873 (FOTO)

WALL - Mobile refrigerato per l'esposizione del vino in bottiglia / Refrigerated Wine Cabinet
DESCRIZIONE/ DESCRIPTION

- Struttura con pannelli isolanti, laminato all'esterno / Structure with insulated laminated panels
- Porta con cornice in alluminio e vetrocamera / Aluminium profile door frame with glass bay
- Raffreddamento ventilato con controllo termostatico / Ventilated refrigeration digitally controlled
- Illuminazione a led e serratura alla porta / Door lock and internal led lighting
- Vaschetta con resistenza per lo smaltimento dell'acqua di condensa / Tank with resistor for disposal of condensed water
- Colori disponibili: grigio alluminio satinato (*873), nero semi-lucido(*421)./Available colours: Brushed Aluminium Gray (*873), semi-Glossy Black(*421)

CARATTERISTICHE TECNICHE / TECHNICAL DATA

T.A.:25°C - U.R. 60%													
CODICE/ CODE	[°C]	up to	L	P	H	L	P	H	[Kg]	[Kg]	Watt	[V/Ph/Hz]	HFC
A1WALLD2BRFRF/*	+6°C ÷ +20°C	240	1200	650	2350	1300	760	2650	160	180	760	230/1/50	R404A
	÷												



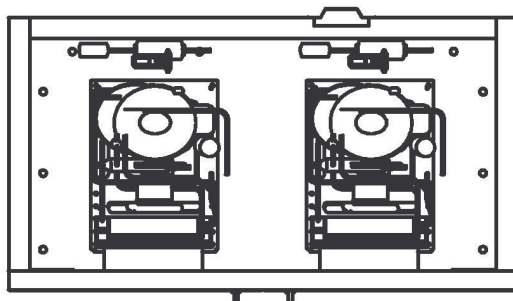
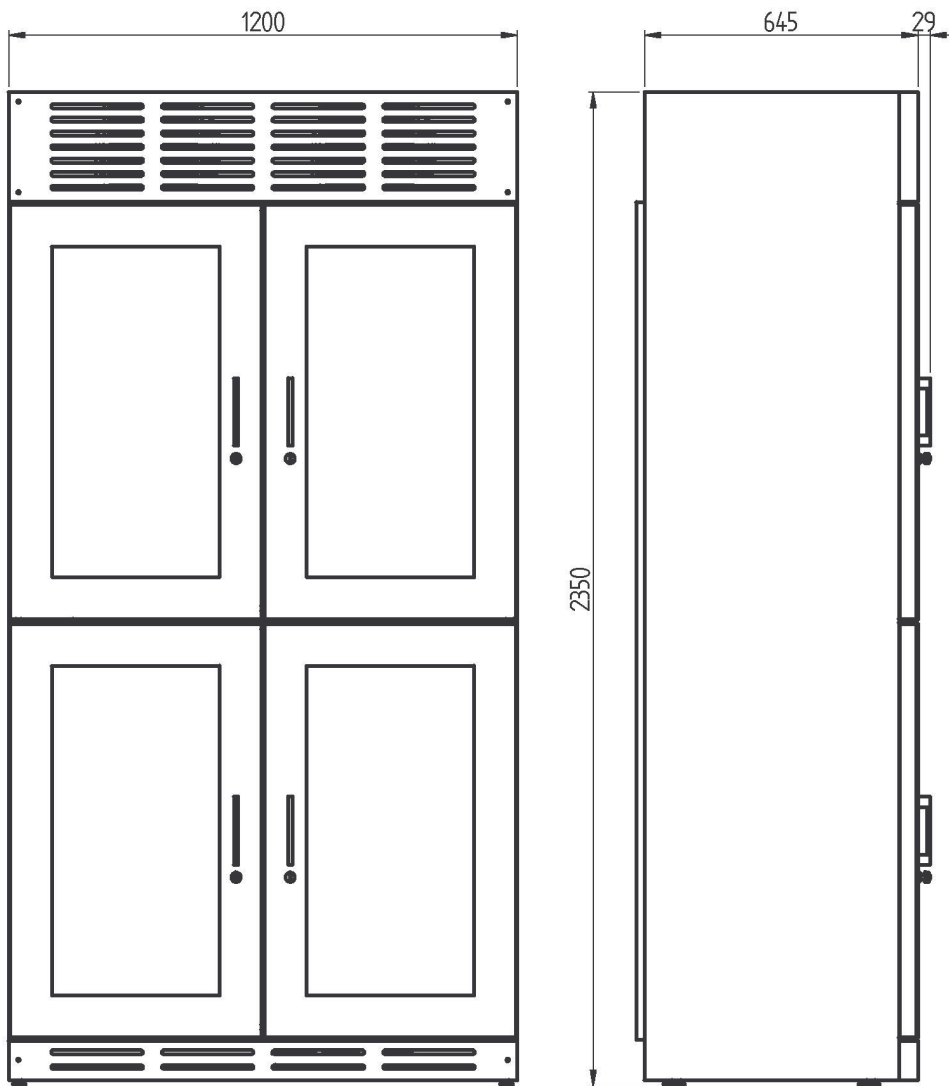



A1WALLD2BRM/873 (FOTO)

WALL - Mobile refrigerato per l'esposizione del vino in bottiglia / Refrigerated Wine Cabinet

DESCRIZIONE/ DESCRIPTION

- Struttura con pannelli isolanti, laminato all'esterno / Structure with insulated laminated panels
- Porta con cornice in alluminio e vetrocamera / Aluminium profile door frame with glass bay
- Raffreddamento ventilato con controllo termostatico COMP. REMOTO / Ventilated refrigeration digitally controlled REMOTE COMP.
- Illuminazione a led e serratura alla porta / Door lock and internal led lighting
- Vaschetta con resistenza per lo smaltimento dell'acqua di condensa / Tank with resistor for disposal of condensed water
- Colori disponibili: grigio alluminio satinato (*873), nero semi-lucido(*421)./Available colours: Brushed Aluminium Gray (*873), semi-Glossy Black(*421)

CARATTERISTICHE TECNICHE / TECHNICAL DATA

CODICE/CODE	T.A.:25°C - U.R. 60%	[°C]	BORDEAUX up to	L P H			L P H			Kg	Kg	Watt	[V/Ph/Hz]	HFC
				L	P	H	L	P	H					
A1WALLD2BRM/*		+6°C ÷ +20°C	240	1200	650	2350	1300	760	2650	160	180	760	230/1/50	R404A
A1WALLD2SRM/*		+6°C ÷ +20°C	240	1200	650	2210	1300	760	2510	120	140	20	230/1/50	R404A
		÷												



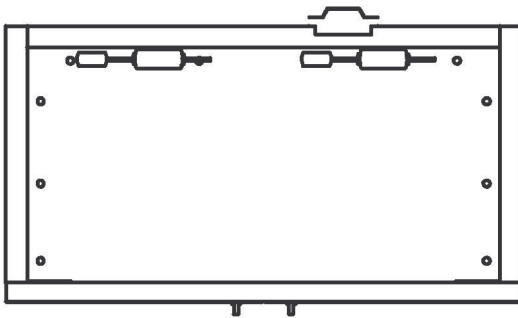
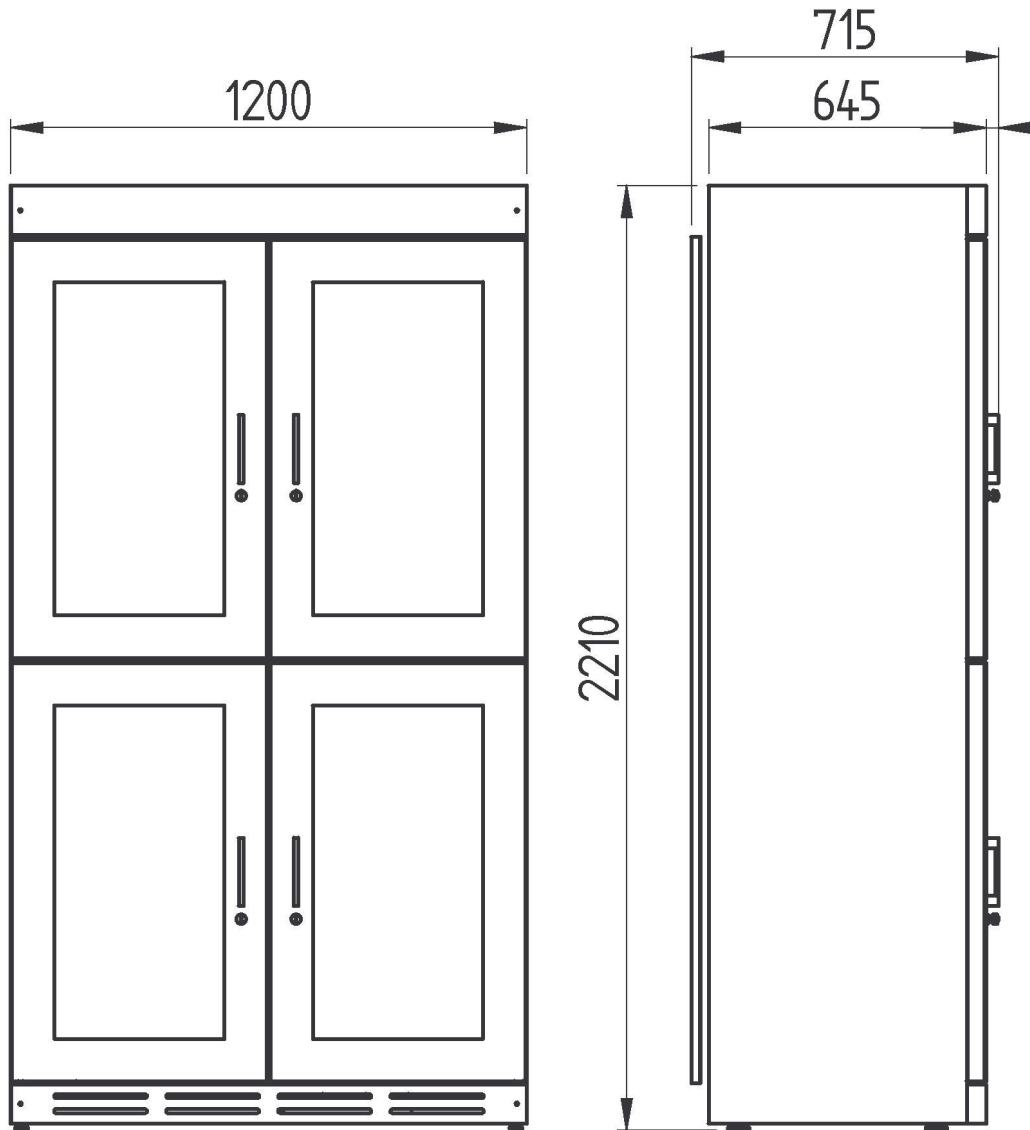











A1WALLS1BRF/873 (FOTO)

Mobile refrigerato per l'esposizione del vino in bottiglia / Refrigerated Wine Cabinet
DESCRIZIONE/ DESCRIPTION

- Struttura con pannelli isolanti, laminato all'esterno / Structure with insulated laminated panels
- Porta con cornice in alluminio e vetrocamera / Aluminium profile door frame with glass bay
- Raffreddamento ventilato con controllo termostatico / Ventilated refrigeration digitally controlled
- Illuminazione a led e serratura alla porta / Door lock and internal led lighting
- Vaschetta con resistenza per lo smaltimento dell'acqua di condensa / Tank with resistor for disposal of condensed water
- Colori disponibili: grigio alluminio satinato (*873), nero semi-lucido(*421)./Available colours: Brushed Aluminium Gray (*873), semi-Glossy Black(*421)

CARATTERISTICHE TECNICHE / TECHNICAL DATA

T.A.:25°C - U.R. 60%													
CODICE/CODE	[°C]	up to	L	P	H	L	P	H	[Kg]	[Kg]	Watt	[V/Ph/Hz]	HFC
A1WALLS1BRF/*	+6°C÷+20°C	60	600	650	1360	700	760	1610	50	60	310	230/1/50	R404A



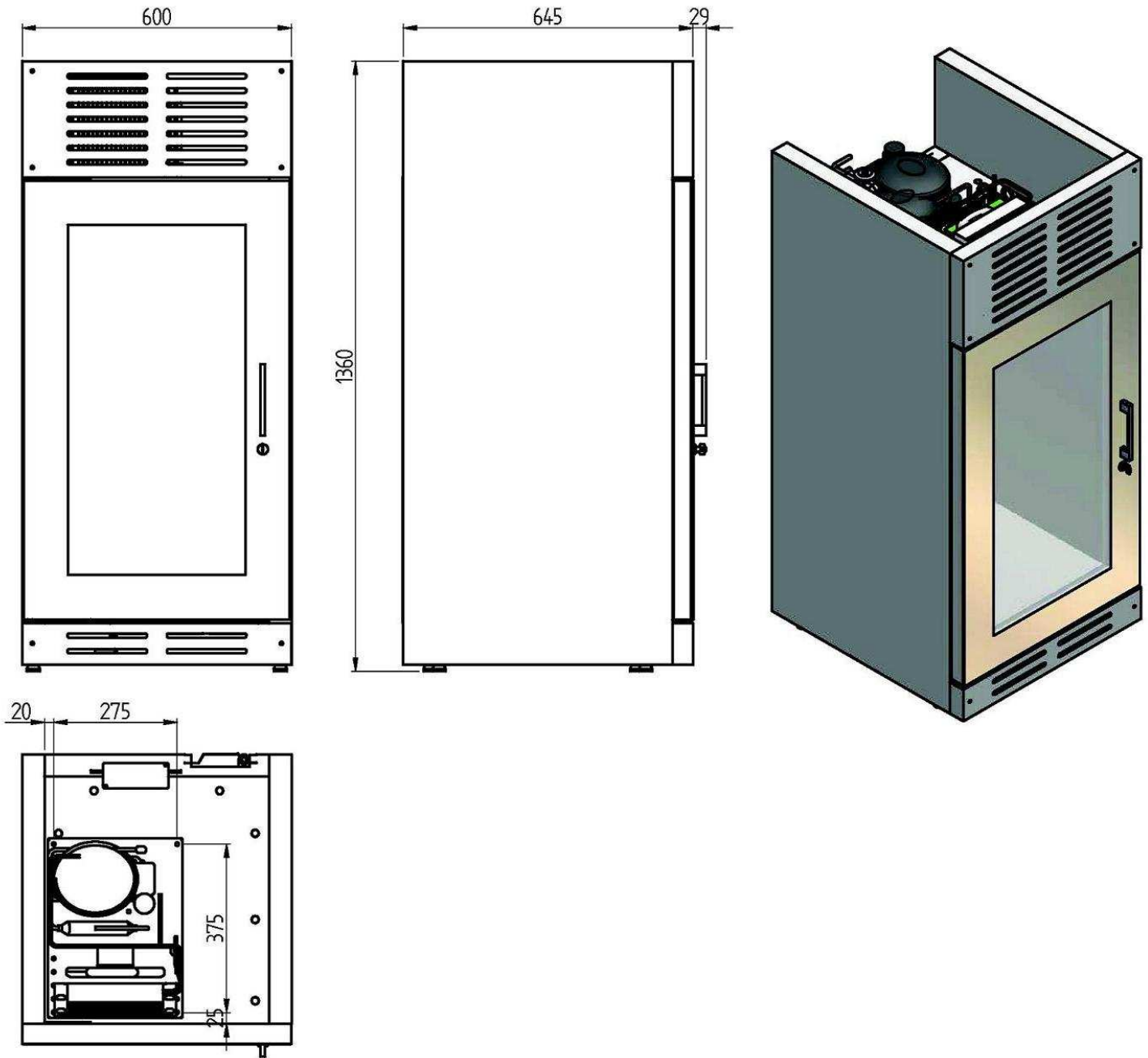











A1WALLS1BRM/873 (FOTO)

Mobile refrigerato per l'esposizione del vino in bottiglia / Refrigerated Wine Cabinet
DESCRIZIONE/ DESCRIPTION

- Struttura con pannelli isolanti, laminato all'esterno / Structure with insulated laminated panels
- Porta con cornice in alluminio e vetrocamera / Aluminium profile door frame with glass bay
- Raffreddamento ventilato con controllo termostatico REMOTO / Ventilated refrigeration digitally controlled REMOTE
- Illuminazione a led e serratura alla porta / Door lock and internal led lighting
- Vaschetta con resistenza per lo smaltimento dell'acqua di condensa / Tank with resistor for disposal of condensed water
- Colori disponibili: grigio alluminio satinato (*873), nero semi-lucido(*421)./Available colours: Brushed Aluminium Gray (*873), semi-Glossy Black(*421)

CARATTERISTICHE TECNICHE / TECHNICAL DATA

T.A.:25°C - U.R. 60%													
CODICE/CODE	[°C]	up to	L	P	H	L	P	H	[Kg]	[Kg]	Watt	[V/Ph/Hz]	HFC
A1WALLS1BRF/*	+6°C÷+20°C	60	600	650	1220	700	760	1470	40	50	10	230/1/50	R404A



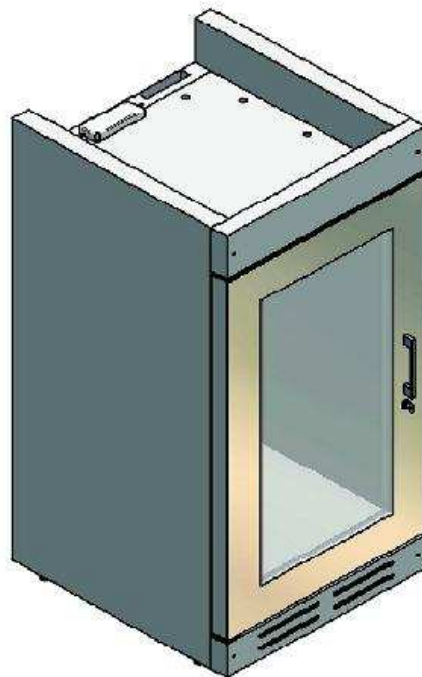
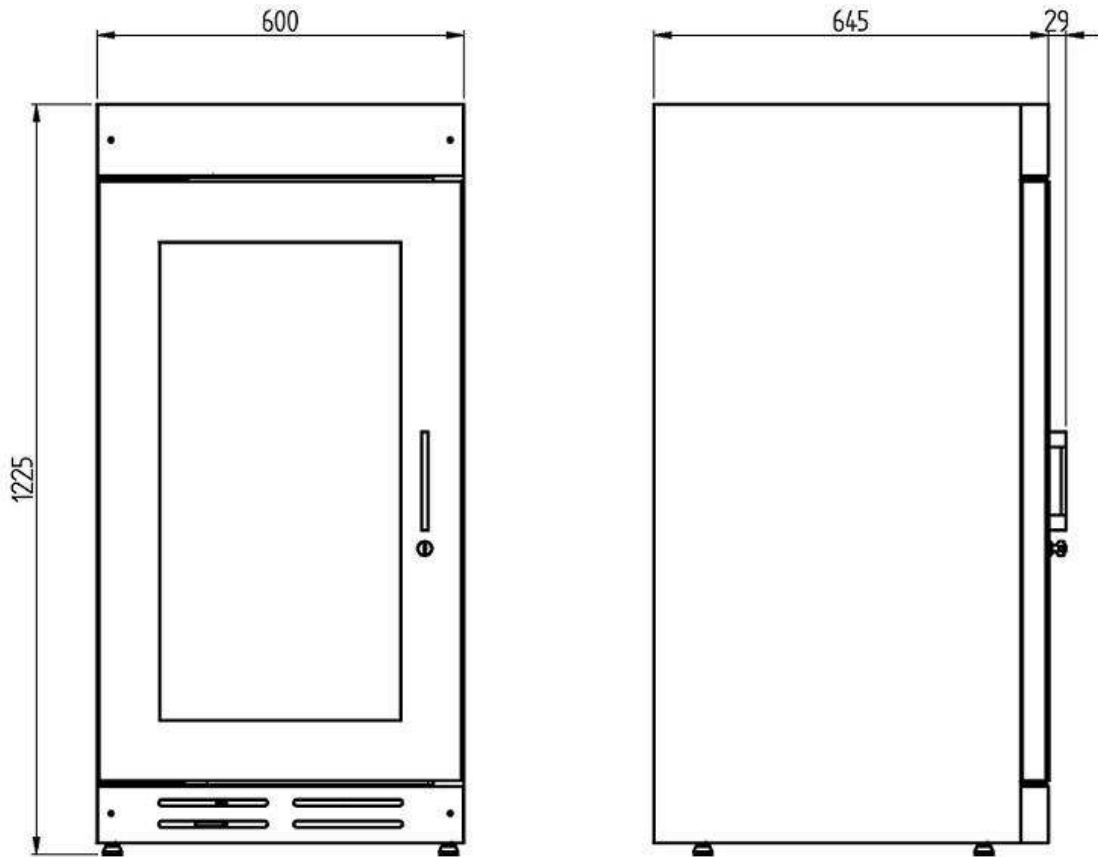











A1WALLS2BRFRF/873 (FOTO)

WALL - Mobile refrigerato per l'esposizione del vino in bottiglia / Refrigerated Wine Cabinet
DESCRIZIONE/ DESCRIPTION

- Struttura con pannelli isolanti, laminato all'esterno / Structure with insulated laminated panels
- Porta con cornice in alluminio e vetrocamera / Aluminium profile door frame with glass bay
- Raffreddamento ventilato con controllo termostatico / Ventilated refrigeration digitally controlled
- Illuminazione a led e serratura alla porta / Door lock and internal led lighting
- Vaschetta con resistenza per lo smaltimento dell'acqua di condensa / Tank with resistor for disposal of condensed water
- Colori disponibili: grigio alluminio satinato (*873), nero semi-lucido(*421)./Available colours: Brushed Aluminium Gray (*873), semi-Glossy Black(*421)

CARATTERISTICHE TECNICHE / TECHNICAL DATA

T.A.:25°C - U.R. 60%													
CODICE/CODE	[°C]	up to	L	P	H	L	P	H	[Kg]	[Kg]	Watt	[V/Ph/Hz]	HFC
A1WALLS2BRFRF/*	+6°C÷+20°C	120	600	650	2350	700	760	2650	90	110	620	230/1/50	R404A
	÷												



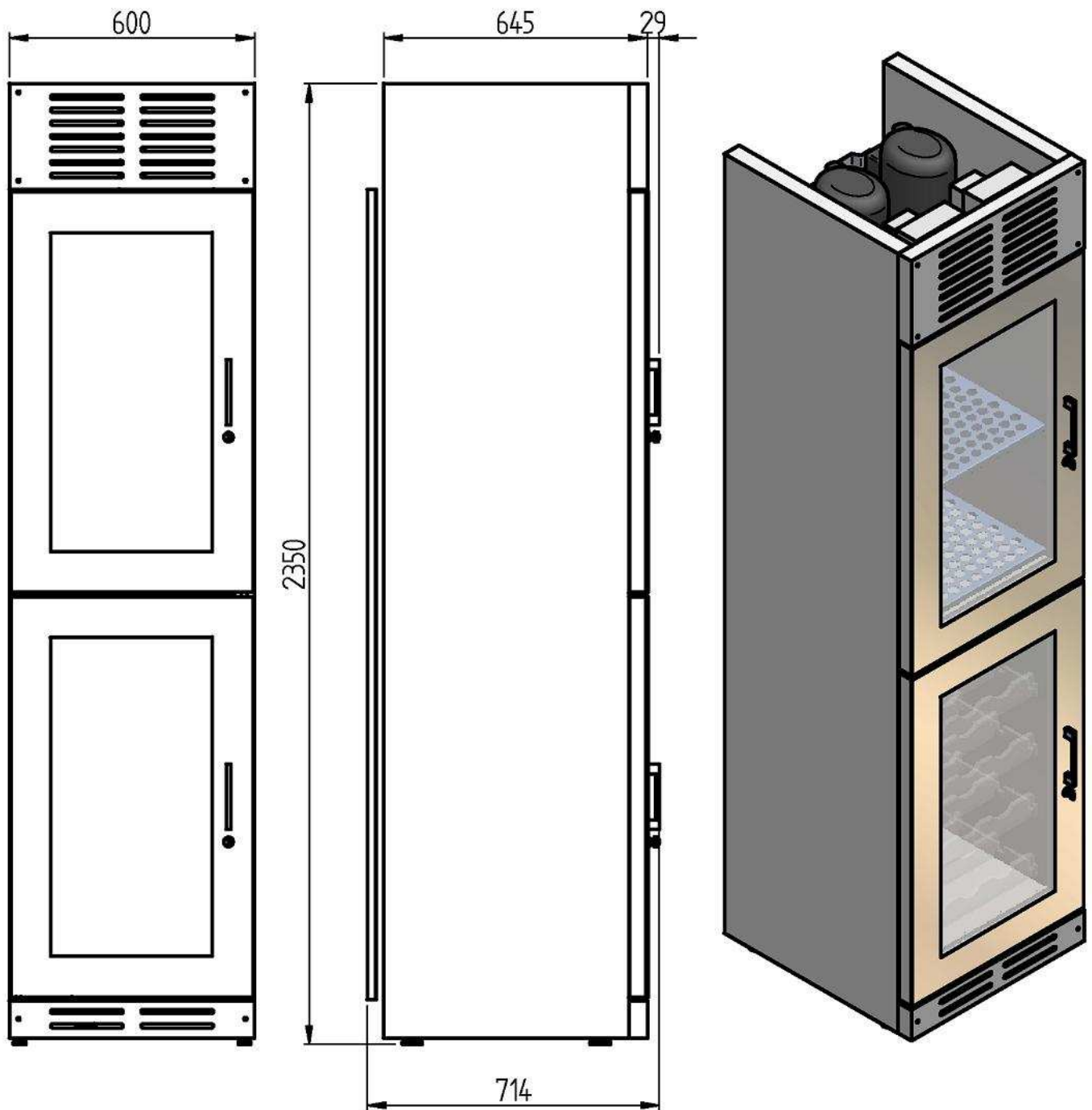











A1WALLS2BRM/873 (FOTO)

WALL - Mobile refrigerato per l'esposizione del vino in bottiglia / Refrigerated Wine Cabinet
DESCRIZIONE/ DESCRIPTION

- Struttura con pannelli isolanti, laminato all'esterno / Structure with insulated laminated panels
- Porta con cornice in alluminio e vetrocamera / Aluminium profile door frame with glass bay
- Raffreddamento ventilato con controllo termostatico COMPRESSORE REMOTO / Ventilated refrigeration digitally controlled REMOTE COMPRESS.
- Illuminazione a led e serratura alla porta / Door lock and internal led lighting
- Vaschetta con resistenza per lo smaltimento dell'acqua di condensa / Tank with resistor for disposal of condensed water
- Colori disponibili: grigio alluminio satinato (*873), nero semi-lucido(*421)./Available colours: Brushed Aluminium Gray (*873), semi-Glossy Black(*421)

CARATTERISTICHE TECNICHE / TECHNICAL DATA

T.A.:25°C - U.R. 60%													
CODICE/ CODE	[°C]	up to	L	P	H	L	P	H	[Kg]	[Kg]	Watt	[V/Ph/Hz]	HFC
A1WALLS2BRFRF/*	+6°C÷+20°C	120	600	650	2350	700	760	2650	80	100	20	230/1/50	R404A
	÷												



